

Dati dimensionali Dimensional features

Volume imballo Packaging Volume	4,7 m ³
Peso netto Net weight	350 kg
Caratteristiche elettriche Electrical features	
Voltaggio Voltage	220/380 volt
Amperaggio Amperage	(220V) 26 A (380V) 15 A
Frequenza Frequency	50/60 Hz
Assorbimento Power absorption	4,5 Kw

Disegno tecnico / Technical drawing

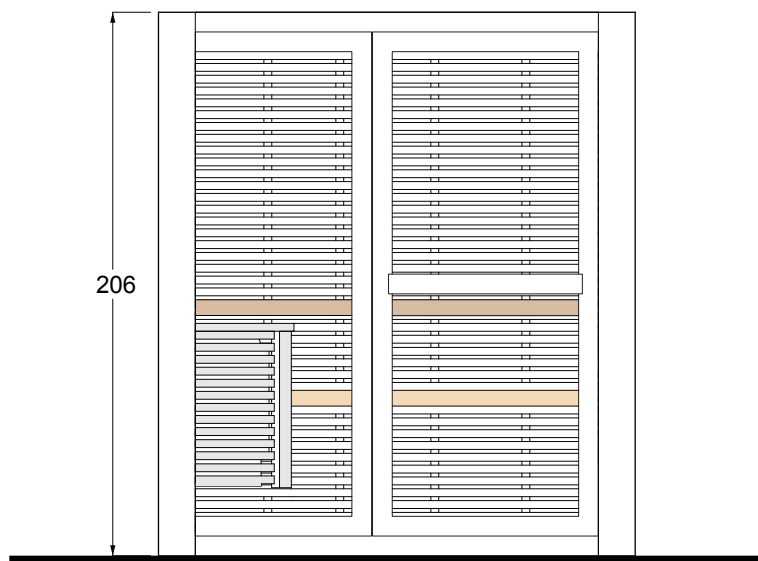
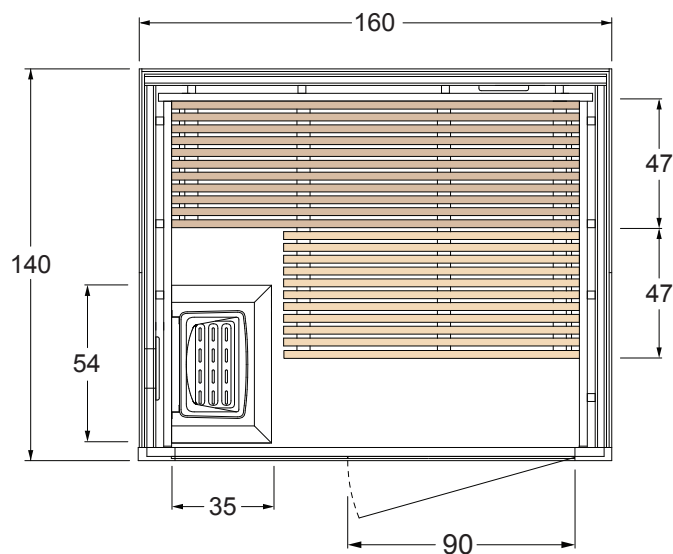

Installazioni disponibili / Installations allowed

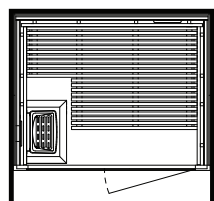

NICCHIA

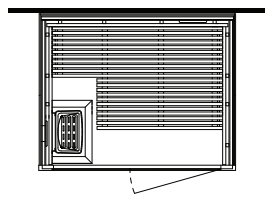

A PARETE

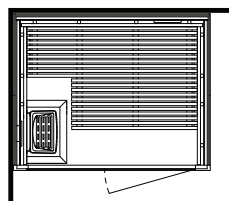

1 (sx)

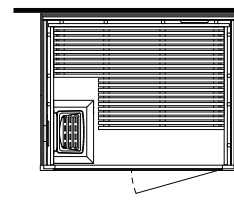

5 (dx)

Installazione idraulica - Installazione elettrica / Hydraulic installation - Electrical installation

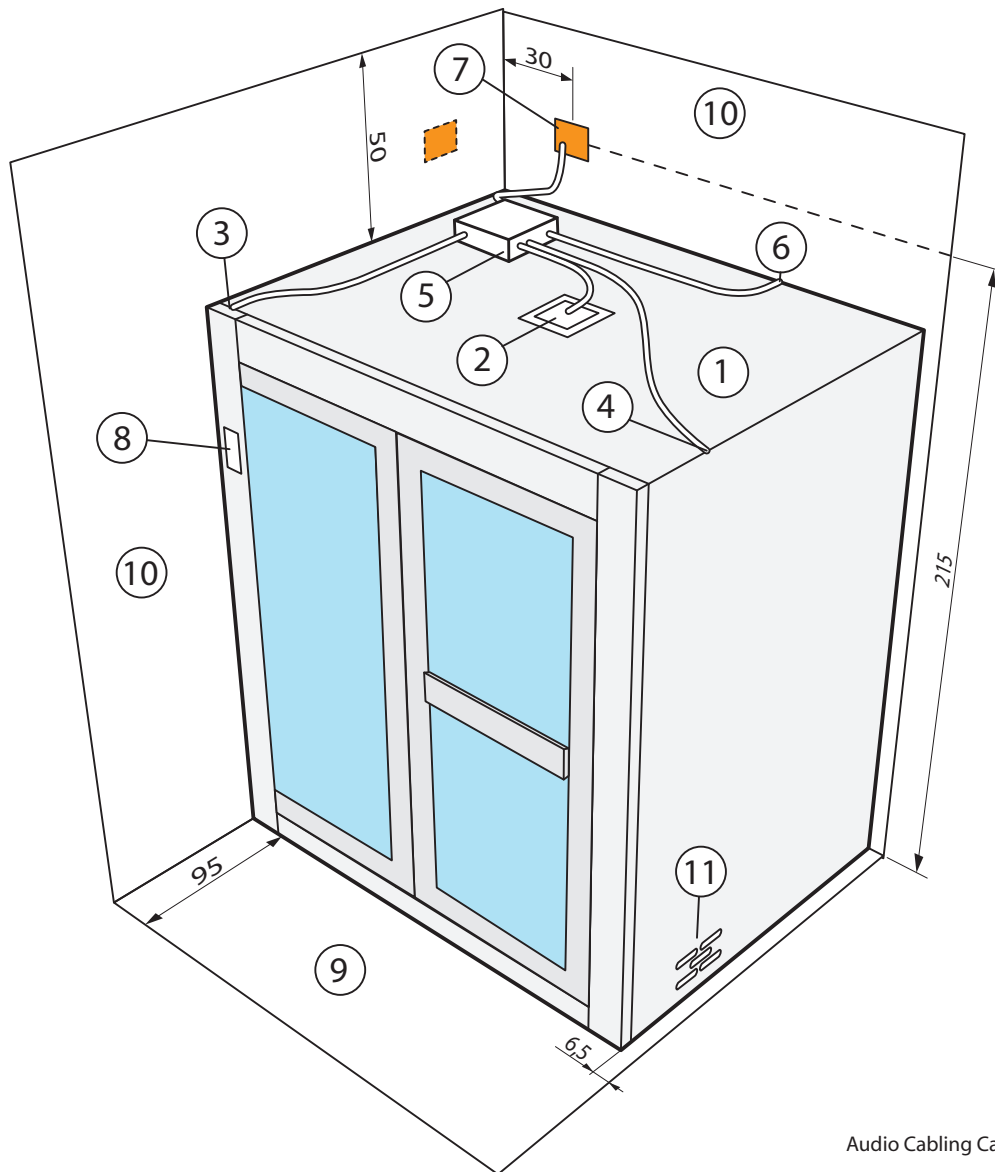

Audio Cabling Case

ITALIANO

Versione sinistra.

La versione destra è speculare.

Dimensioni di ingombro in centimetri.

- 1 - Cabina Sauna
- 2 - Cablaggio Faretto RGB
- 3 - Cablaggio Pannello Touch
- 4 - Cablaggio Sensori
- 5 - Quadro Potenza
- 6 - Cablaggio illuminazione sottopanca
- 7 - Scatola derivazione
- 8 - Pannello Controllo Touch
- 9 - Area libera fronte Sauna
- 10 - Area libera sopra e fianco pareti
- 11 - Griglia Aria Generatore Sauna

■ = Aree disponibili per gli allacciamenti.

ENGLISH

Left side version.

For the right side version, reverse the drawing.

Overall dimension in centimetres.

- 1 - Cabin Sauna
- 2 - Wiring RGB Spotlight
- 3 - Touch Panel Wiring
- 4 - Wiring Sensors
- 5 - Power Box
- 6 - Wiring seats spotlight
- 7 - Power box
- 8 - Touch Control Panel
- 9 - Sauna open area in front
- 10 - Open area on top and side walls
- 11 - Air Grid Generator Sauna

■ = Area for positioning of the outlets.